

PROPRIETARY NOTICE: THIS DRAWING CONTAINS PATENTED, PATENT APPLIED FOR, AND/OR OTHER CIRCUITRY CONSIDERED PROPRIETARY BY AUDIO RESEARCH CORPORATION AND IS FURNISHED ON A CONFIDENTIAL BASIS FOR IDENTIFICATION PURPOSES ONLY.

AUDIO RESEARCH CORPORATION
 5740 GREEN CIRCLE DRIVE
 MINNETONKA, MINNESOTA 55343-4424

LS22 PREAMPLIFIER
 AUDIO
 PAGE 1 OF 3 6-23-95

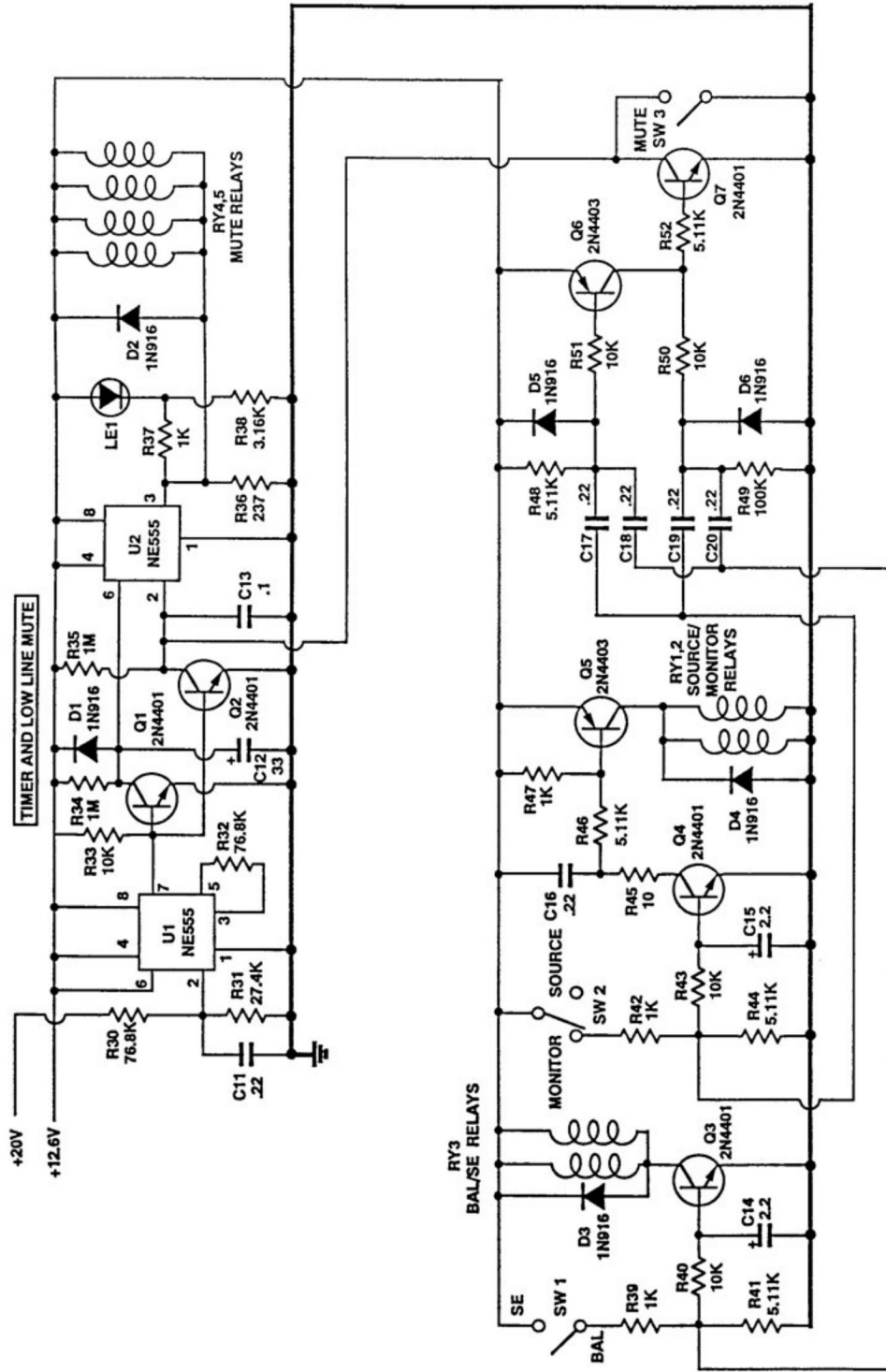

PROPRIETARY NOTICE: THIS DRAWING CONTAINS PATENTED, PATENT APPLIED FOR, AND/OR OTHER CIRCUITRY CONSIDERED PROPRIETARY BY AUDIO RESEARCH CORPORATION AND IS FURNISHED ON A CONFIDENTIAL BASIS FOR IDENTIFICATION PURPOSES ONLY.

AUDIO RESEARCH CORPORATION
5740 GREEN CIRCLE DRIVE
MINNETONKA, MN 55343-4424

LS22 PREAMPLIFIER
MUTE AND SWITCHING
PAGE 2 OF 3 6-23-95

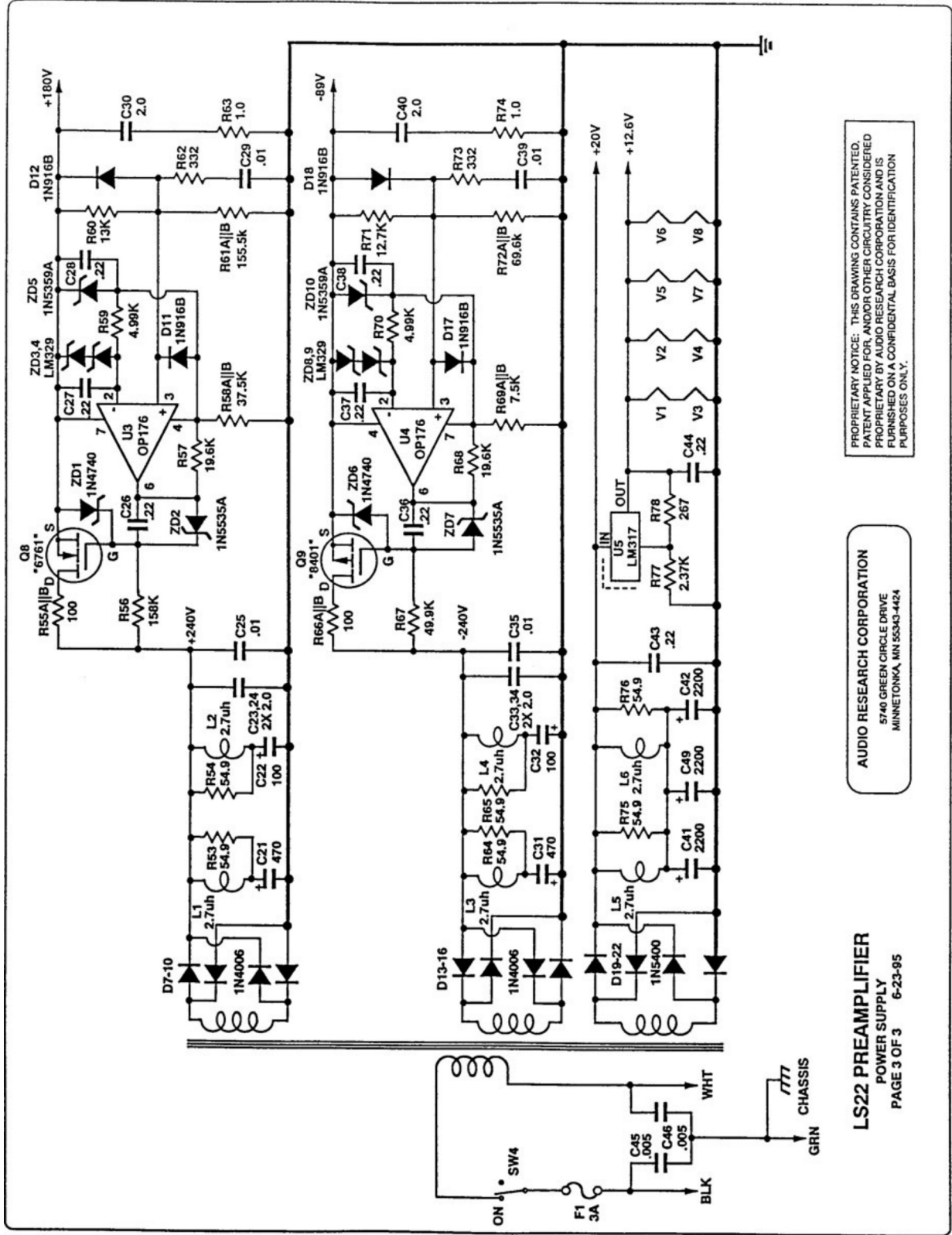

PROPRIETARY NOTICE: THIS DRAWING CONTAINS PATENTED, PATENT APPLIED FOR, AND/OR OTHER CIRCUITRY CONSIDERED PROPRIETARY BY AUDIO RESEARCH CORPORATION AND IS FURNISHED ON A CONFIDENTIAL BASIS FOR IDENTIFICATION PURPOSES ONLY.

AUDIO RESEARCH CORPORATION
5746 GREEN CIRCLE DRIVE
MINNETONKA, MN 55343-4424

LS22 PREAMPLIFIER
POWER SUPPLY
PAGE 3 OF 3 6-23-95